

**CABIN 1**

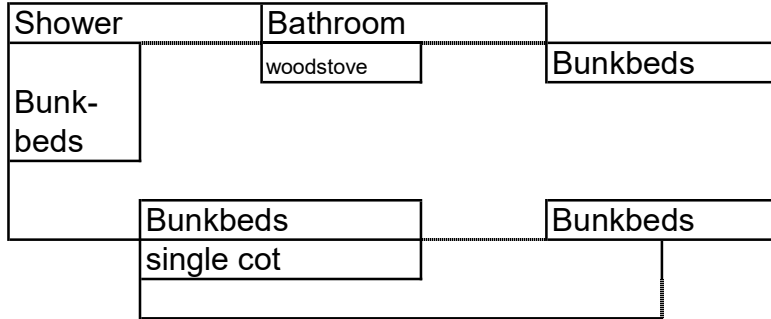

**Bed count: 9**

- 4 top bunk
- 4 bottom bunk
- 1 single cot

**CABIN 2** - fully accessible

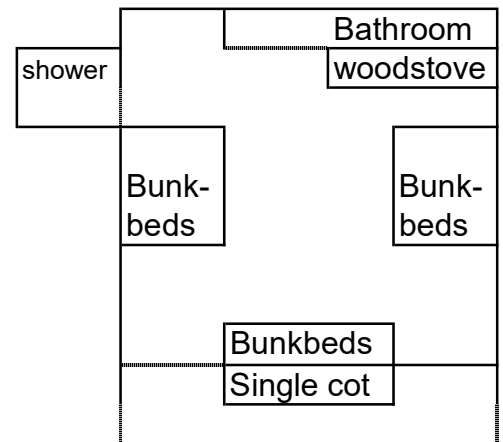

**Bed count: 7**

- 3 top bunk
- 3 bottom bunk
- 1 single cot

**CABIN 3**

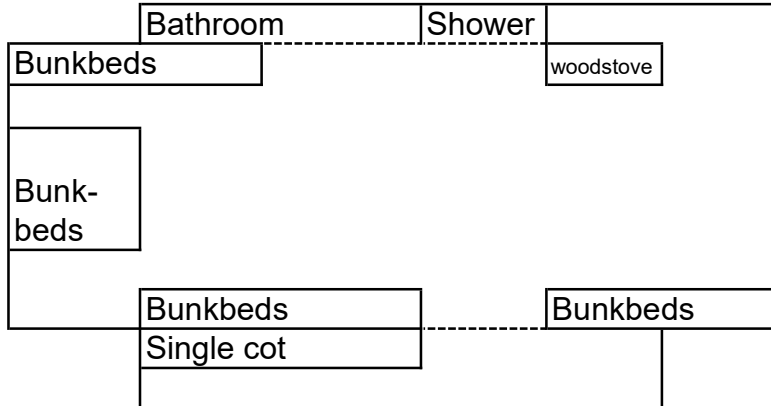

**Bed count: 9**

- 4 top bunks
- 4 bottom bunks
- 1 single cot

**CABIN 4**

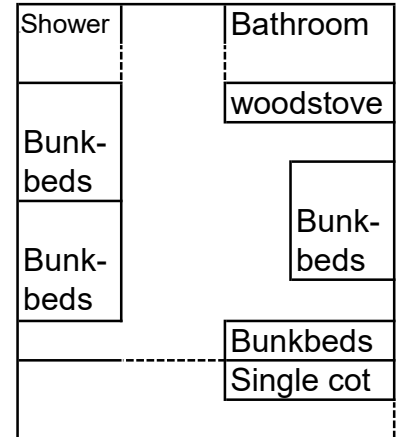

**Bed count: 9**

- 4 top bunks
- 4 bottom bunks
- 1 single cot

**CABIN 5** - fully accessible

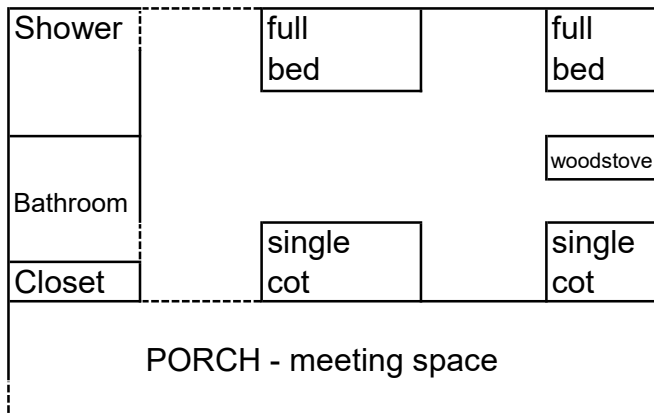

**Bed count: 4**

- 4 single beds

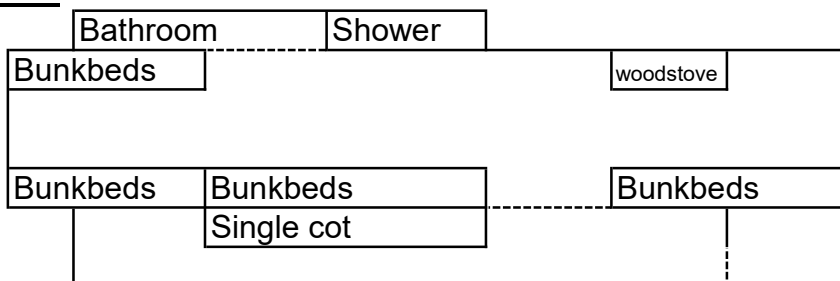
**CABIN 7****Bed count: 9**

4 top bunks  
4 bottom bunks  
1 single cot

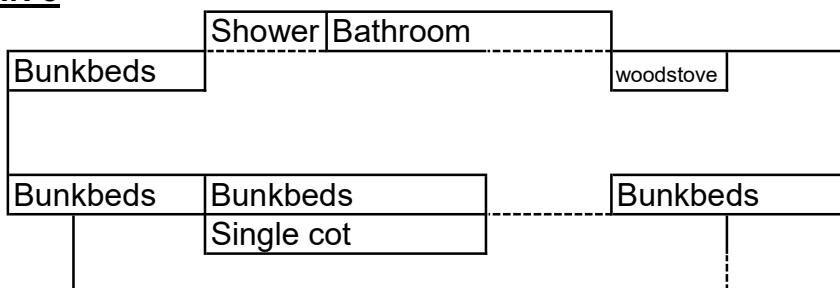
**CABIN 8****Bed count: 9**

4 top bunks  
4 bottom bunks  
1 single cot

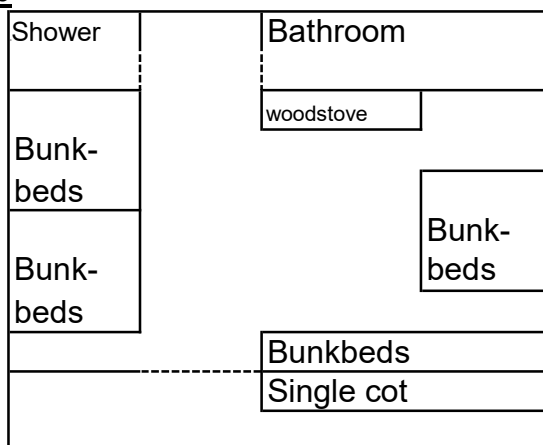
**CABIN 10****Bed count: 9**

4 top bunks  
4 bottom bunks  
1 single cot

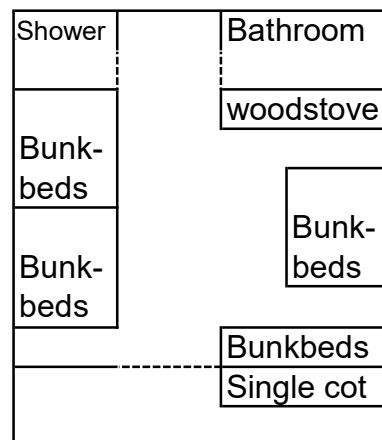
**CABIN 6****Bed count: 9**

4 top bunks  
4 bottom bunks  
1 single cot

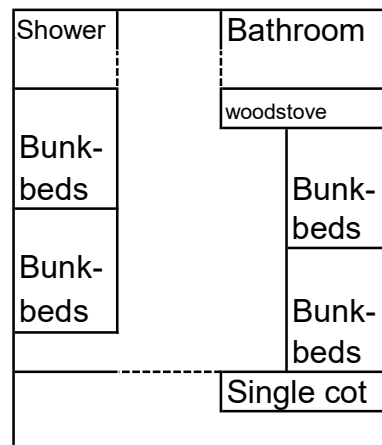
**CABIN 9****Bed count: 9**

4 top bunks  
4 bottom bunks  
1 single cot

**CABIN 11**

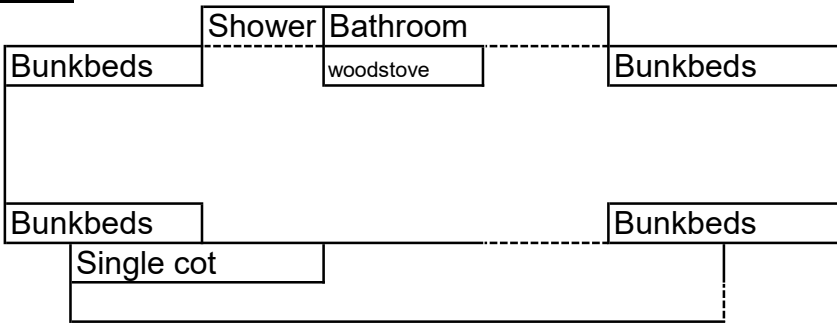

**Bed count: 9**

- 4 top bunks
  - 4 bottom bunks
  - 1 single cot
- PLUS plenty of room inside for 1-2 additional cots**

**CABIN 12**

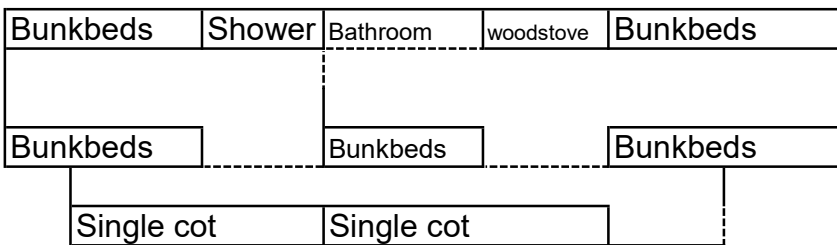

**Bed count: 12**

- 5 top bunks
- 5 bottom bunks
- 2 single cots

**CABIN 13**

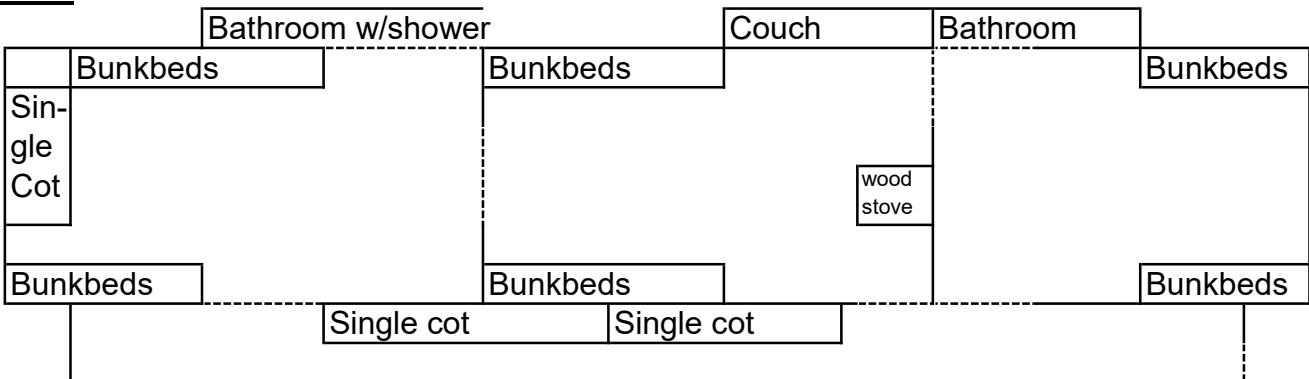

**Bed count: 15**

- 6 top bunks
- 6 bottom bunks
- 3 single cots

**FORRESTER**

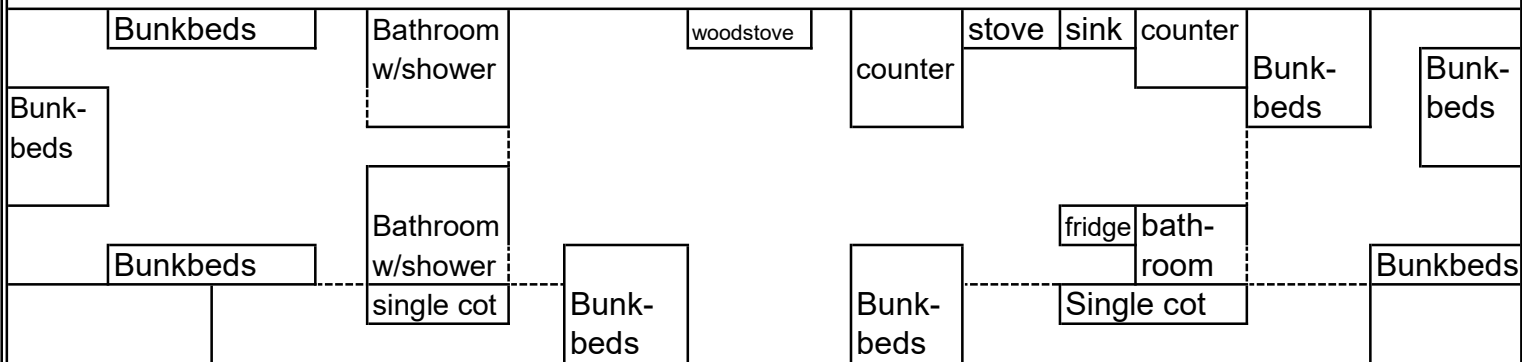

**Bed count: 18**

- 8 top bunks
- 8 bottom bunks
- 2 single cots

**PLUS plenty of room inside for 1-2 additional cots**

**CABIN S2**

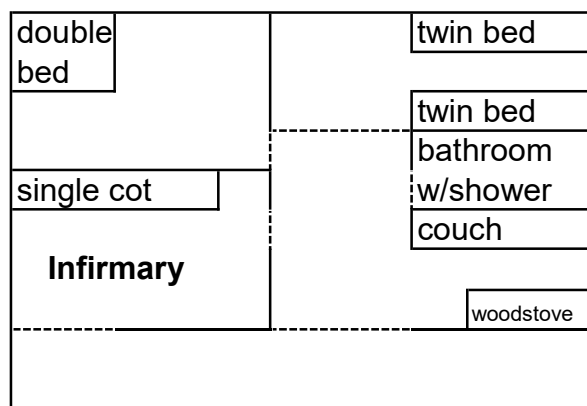

**Bed count: 3**

- 2 twin beds
- 1 double bed

**CABIN S3**

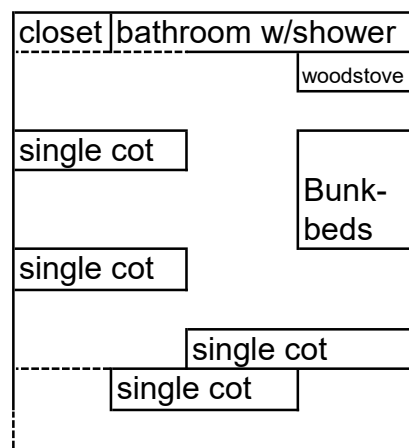

**Bed count: 6**

- 1 top bunk
- 1 bottom bunk
- 4 single cots

**CABIN S4**

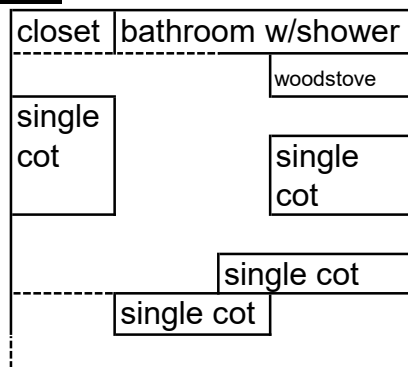

**Bunk count: 4**